

Premium Clear Redwood Rectangular Bin

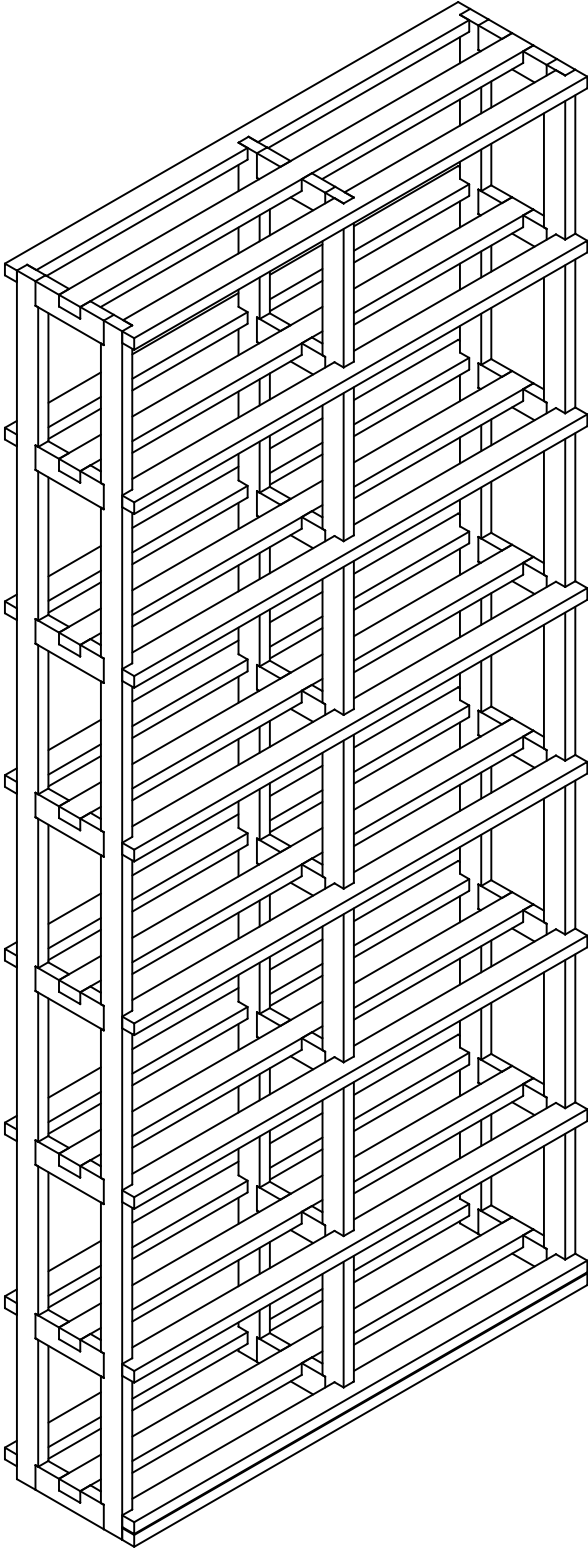

Rectangular Bin

Parts List

#	qty.	description
A	3	Racks
B	8	Slats
C	17	Spacer bars
*	1	Bag of nails
*	1	Hardware Pack containing 2 angle brackets 2 plastic anchors 2 1" #8 screws 2 5/8" #6 screws

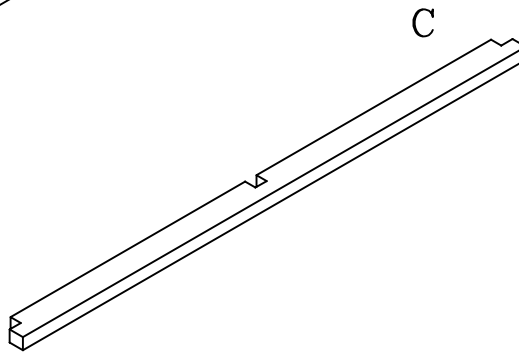
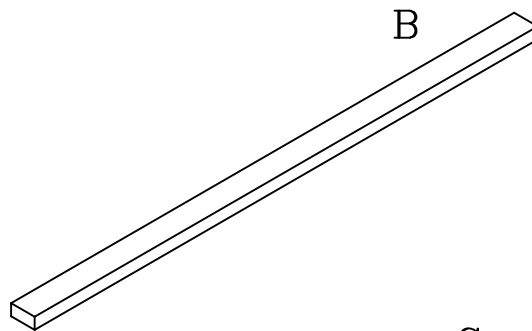
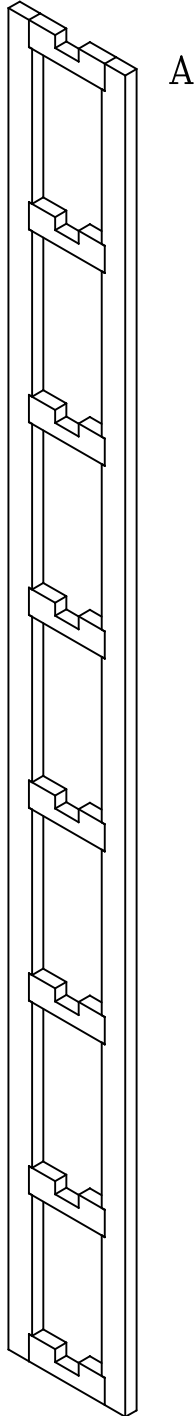

1.

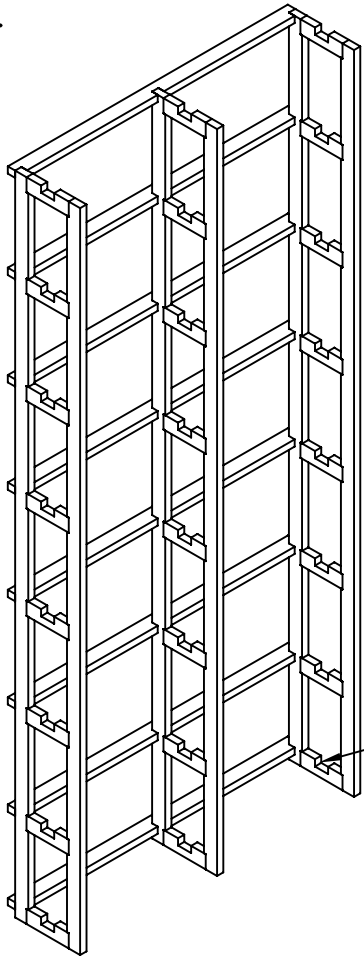

a. Attach (8) spacer bars to racks with nails
 Nail the nails into each spacer bar. This can be done with the provided nails or with a brad nailer.

notches on rails
 need to face ceiling

Spacer bars should be
 flush with the top of
 the rails.

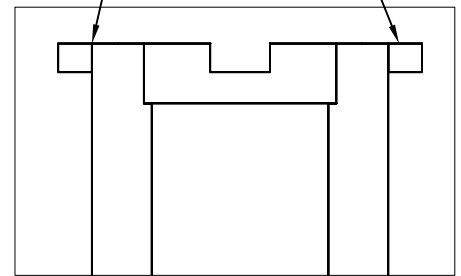

2.

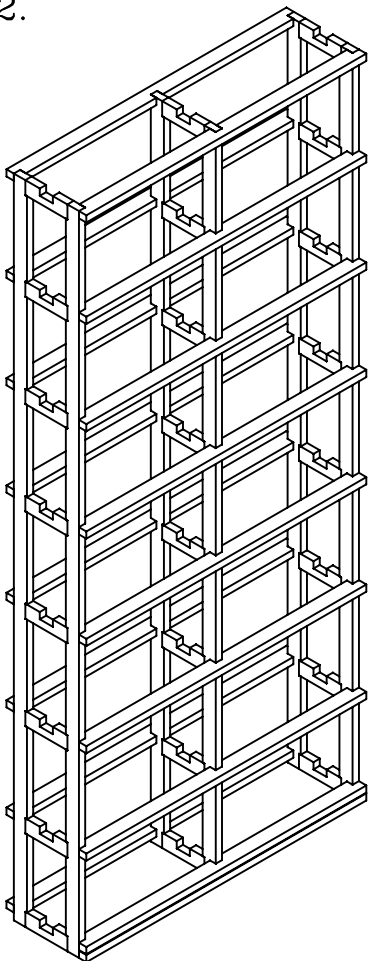

Attach 9 spacer bars
 to the front of the
 racks as in step 1.

Note: 2 spacer bars
 are stacked on the
 bottom.

3.

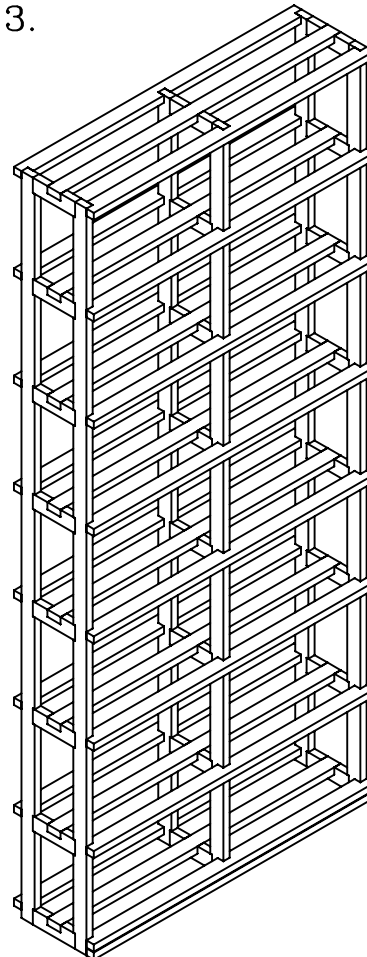

Insert (8) slats into
 notched rails.

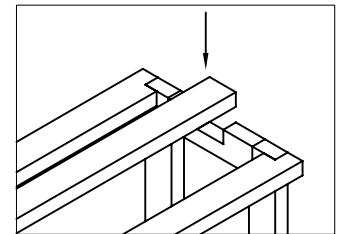

4.

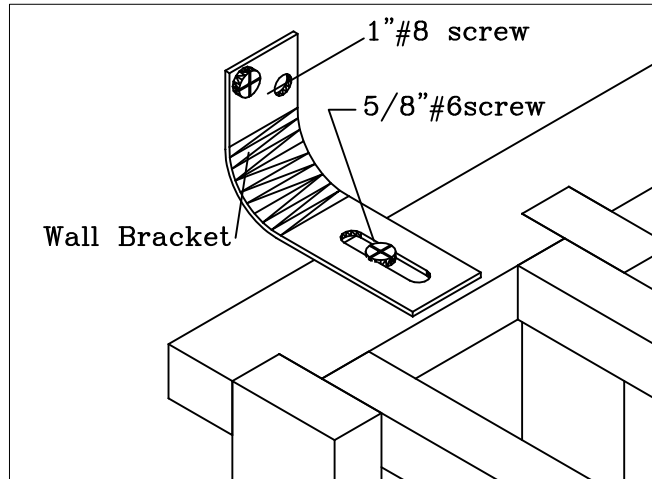

Secure rack to wall by attaching wall brackets to top back spacer bar. You will have 1 bracket on the left and 1 on the right.

Rectangular bin
assembly complete.

always remove bottles before moving racks.